

CARGO FLOOR USER MANUAL

We would like to introduce to you the right operation of our Cargo Floor system with the help of the following data and we also want to point out to you the steps that you can take to solve malfunctions.

Please read and follow our instructions carefully so that the Cargo Floor system will give you reliable and trouble free service for many years and **health and safety** is secured.

If the Cargo Floor system does not operate at all (or properly) after following the instructions, please do not hesitate to contact your nearest agent, who will with no doubt assist you in solving the problem.

Please pay particular attention to the contents of the “Important recommendations and guidelines” on page 2 and further!

The measurements given in this instruction start with the metric system after which between brackets [0] the US/imperial measurement is mentioned.

TABLE OF CONTENTS

General	1
Important recommendations and guidelines	2
Health and safety short list	4
Emergency stop	5
Start up check list for operation (unloading / loading)	5
Stickers	6
The Cargo Floor moving floor principle	8
Modular operating possibilities	9
Wet kit information.....	10
Hydraulic start-Up check list for the Cargo Floor System	11
Identification plate	12
Cargo Floor technical specifications	13
Maintenance instructions.....	14
Adjustment of the threaded rod of the control valve	15
Warranty conditions.....	16
A-control	18
Control valve	18
Loading – unloading function.....	18
Hydraulic circuit diagram A-control	19
Troubleshooting A-control valve	20
B-Control	21
Control valve	21
Loading – unloading function.....	21
Function of B-control Switches	22
Manual override B-control.....	24
Electrical circuit diagram B-control.....	25
Hydraulic circuit diagram B-control	26
Troubleshooting B-control valve	27
E-control	28
Control valve	28
Function of E-control switches.....	29
Manual override E-control.....	31
Electrical circuit diagram E-control.....	32
Hydraulic circuit diagram E-control	33
Choke.....	34
Troubleshooting E-control.....	35

USER MANUAL SLC

IMPORTANT RECOMMENDATIONS AND GUIDELINES

Before putting the Cargo Floor loading and unloading system into operation, follow the recommendations provided below and check the specified checkpoints to avoid damage to the Cargo Floor system and the vehicle.

Please review the important instructions before operating the Cargo Floor system and loading cargo into the vehicle. Likewise, before loading cargo, check the operation of the various control switches/valves to familiarise yourself with how the system works. We strongly recommend that you perform these checks when picking up the vehicle from the dealer so that your skilled supplier can answer your questions and provide you with any necessary advice or guidance you may require.

Important:

- Always check that the selected loading or unloading direction is actually activated and occurring!!
- If the system fails to start, turn off the Cargo Floor system and the hydraulic pump and follow the recommendations and guidelines provided below. Do not repeatedly try to start the system as this may result in damage to your Cargo Floor system and/or vehicle.
- After use, turn off the Cargo Floor system and hydraulic pump. Set switches to the "0" position and the lever in neutral.

In case of doubt or uncertainty about these recommendations and guidelines, always contact your dealer or an official workshop.

The Cargo Floor system comes standard with an operating manual, but if this has not been supplied, please contact your dealer or download it from the official Cargo Floor website: www.cargofloor.com

- A) Always open the vehicle's doors before turning on the hydraulic pump. Note! Build-up of pressure against the doors can open them with force. Also some of the cargo can fall out of the vehicle by itself after opening the doors, therefore **KEEP CLEAR AT ALL TIMES**, product could fall on top of you! Both could result in damages and/or injuries! It is always advisable to use the pneumatic door lock, if provided.
- B) 1. Check that the vehicle's (quick-detachable) couplings are properly connected to the P (Pressure line) and the T (tank/return line). Also check that the couplings are fully tightened or slid completely into each other.
IMPORTANT: the pressure and return line connectors may not be reversed or exchanged to prevent dirt or water from entering the lines when connecting them!
2. Before connecting, check that the non-return valves can open easily (check: the non-return valves should open easily when pressed with the finger, if not, potential pressure build-up in the hydraulic lines may be preventing the system from starting).
NOTE: Incorrectly connected or unopened hydraulic couplings will cause serious damage to the Cargo Floor system and the vehicle.
- C) The vehicle (pump) must be fitted with a pressure relief valve that is set at the maximum pressure according to the system, see the technical specs. If fitted, check that the dual-function lever (function: tipper/Cargo Floor) is in the Cargo Floor position. Pressure may not exceed the maximum adjusted and allowable operating pressure of the Cargo Floor system. An incorrectly adjusted pressure relief valve can cause damage to the Cargo Floor system and the vehicle.
- D) During operation, the (hand)brake of the vehicle must always be applied. You must, however, move the vehicle forward on time to unload it quickly in order to prevent unnecessary strain and wear to the floor and the vehicle.
- E) Use of a wireless remote control is permitted only if it is fully tested before the start of each loading or unloading operation. Always check if the function you have selected is actually activated and taking place. If, for example, you have accidentally pressed the load function when you actually meant to press the unload function, irreversible damage may occur to the Cargo Floor system and the vehicle.
- F) During operation of the Cargo Floor system, all existing STOP and control knobs/levers must be freely accessible.

- G) The pressure filter element needs to be replaced at least once a year. If the couplings between the vehicle and the Cargo Floor system are regularly removed, it is advisable to check the pressure filter for dirt build-up and replace the pressure filter element more often, if necessary. If provided, also check the return filter (not supplied with the Cargo Floor). Failure to replace a filter element on time may cause damage to or malfunctions in the Cargo Floor system and the vehicle.
- H) Moving parts must be shielded. Always maintain at least 10 meter [30'] distance from the Cargo Floor system when it is in operation.
- I) In the event of malfunctions/maintenance work, you may approach the Cargo Floor system only if all equipment, including the hydraulic pump, have been shut off, and the Cargo Floor system and the electro-hydraulic aggregate have been disconnected from the power supply and pump.
- J) Regularly check and, if necessary, tighten any loose bolts that secure the aluminium floor profiles to the Cargo Floor system. All such checks can simply be performed inside the vehicle itself by qualified personnel. The Cargo Floor system must, however, be turned on in unloaded condition and the person performing the check must place his finger half on the floor profile and half on the bolt. There should be no appreciable movement/space between the floor profile and bolt. Failure to check these bolts may lead to damage to the Cargo Floor system. During this check, a second person must also be present to switch off the Cargo Floor system.
- K) Check that the minimum required amount of oil is present 150 liter [40 US gallon]. Too little oil in the hydraulic tank will cause damage to both the pump and the Cargo Floor system.
- L) Do not allow the number of strokes to exceed the maximum allowable 16 power strokes per minute. Only a CF500 SLC Power Speed Cargo Floor system may deliver up to 23 beats per minute. A higher number of power strokes can cause damage to the Cargo Floor system and the vehicle.
- M) Hydraulic lines, couplings and hoses with very small diameters will cause damage.
- N) If the Cargo Floor system fails to start or operates incorrectly, the Cargo Floor system and the hydraulic pump must be shut down immediately. Subsequently, check all the checkpoints before switching the pump and the Cargo Floor system back on. To prevent the oil from overheating, regularly check the oil temperature by CAREFULLY and CAUTIOUSLY touching the line and or oil tank. If either is too hot to the touch, stop touching them right away. **WARNING: TOUCHING OVERHEATED OIL AND COMPONENTS CAN CAUSE BURNS!**
- O) The cause of failure or malfunctioning of the Cargo Floor system may also be due to other hydraulic components that may or may not be connected to the same hydraulic circuit of the Cargo Floor system.
- P) Jamming of the floor profiles caused by the transport of abnormal loads and or the freezing of the floor or of the product to the floor may result in damage to the Cargo Floor system and the vehicle. Recommendation: in the event of freezing, stop the system and try to find a hall (heated area) to allow the product to thaw.
- Q) Because the electrical power supply of the Cargo Floor system is often connected to the lighting circuit of the vehicle, it is advisable to turn on the lighting throughout the operation of the system.
- R) Maintenance and repairs to the Cargo Floor system may be only performed by qualified personnel. Use only original Cargo Floor components to ensure maximum reliability and long service life.
- S) Maximum cargo weight is subject to the limits set by law and applicable regulations. Even if the system can transport heavier loads, the law determines the maximum limit. Excessively heavy cargo can cause damage to the Cargo Floor system and the vehicle.
- T) Check that the correct type and quality of hydraulic oil is used. The use of incorrect oil type may cause damage to the Cargo Floor system and the pump.
- U) Check the vehicle for correct voltage. Make sure there are no open electrical connections. A faulty electrical system can cause damage to the Cargo Floor system and the vehicle.
- V) Check that the bulkhead, if present, is functioning smoothly and properly. A properly functioning bulkhead ensures that the product is unloaded in a clean and quick fashion. A malfunctioning bulkhead may extend the unloading time and cause damage to the vehicle.
- W) Use of the Cargo Floor system by unqualified personnel can cause damage to the Cargo Floor system and the vehicle.
- X) Excessively high oil temperatures will cause damage to the Cargo Floor system and other hydraulic components, such as the pump.
- Y) It is at all times advisable to stop the Cargo Floor system when all the piston rods are retracted. This is usually the case when the floor profiles are positioned towards the unloading end (vehicle doors). Unretracted piston rods may cause damage to the Cargo Floor system.

- Z) To prevent damage to the floor profiles, exercise caution and limit the dump height as much as possible. The transport of unauthorised goods, such as aggressive, corrosive, hot, hard, sharp and viscous materials may cause damage to the Cargo Floor system and the vehicle. Avoid loading and unloading sharp objects. Loads that are softer than the hardness of the floor profiles will extend the service life of your system; if in doubt, use a protective cloth or consult your dealer.
- AA) Forklift trafficable. In principle, the floors are completely trafficable and can be driven over by forklifts, but always consult your dealer for advice on the maximum loads allowed on your vehicle. Overloading will cause damage to the Cargo Floor system and the vehicle.
- BB) Always return emergency control(s) to their original non-activated position after use.
- CC) During the operation of the system, test the temperature of the oil by touching the side of the tank. If the oil is so hot that you cannot continue to touch the tank, switch off the pump to allow the oil to cool off and determine what is causing the overheating. Stop loading or unloading if the oil is too hot, as this will irreversibly cause damage to the Cargo Floor system and the other hydraulic components.
WARNING: TOUCHING OVERHEATED OIL AND COMPONENTS CAN CAUSE BURNS AND INJURIES!
- DD) During loading and unloading operations, the load should be spread to give an even weight distribution over the floor area, otherwise the load may stall. Tip: when transporting pallets, place softwood boards of 300 x 18 x 2350 mm. [12" x 0.75" x 92.5"] to distribute the pressure more evenly.
- EE) The constant pressing of the load against the head board or the doors can lead to extra wear of the complete system. Also the construction can be damaged. Please consult your supplier about the optimizing possibilities or in order to prevent problems occurring.
- FF) The user/operator/driver that is operating the Cargo Floor system is compelled to remain a safe distance from the Cargo Floor system at all times, from the time of switching on the hydraulic pump until turning it off. He should ensure that no dangerous situations can occur. When the process malfunctions or if other people are present he should shut down the Cargo Floor system, or hydraulic pump, immediately.
- GG) No unauthorized alterations/modifications/changes/adjustments may be made to any part of the Cargo Floor drive unit and system.

WARRANTY

Warranty is subject to prior approval by Cargo Floor B.V.! To request warranty coverage, visit www.cargofloor.com to fill out and submit the warranty application form provided there; do not forget to include your Cargo Floor system number on the form.

HEALTH AND SAFETY SHORT LIST

1. During operation, the (hand)brake of the vehicle must always be applied.
2. Check surroundings, at all times, that no persons, animals or objects are in the direct vicinity of the vehicle.
3. Caution when opening the doors. There could be backpressure from the product to the doors which could force the doors to open themselves and injure you, also product could fall on top of you!
4. Do not stand behind the trailer or in the discharge area when the floor is operating
5. Do not make adjustments to the unloading mechanism with the floor operating
6. Do not operate system when protective covers and screens are not in place
7. Do not go underneath the trailer when floor is operating
8. Do not leave the trailer unattended while the Cargo Floor system is in operation
9. Do not hold the conduits these can be hot
10. Disengage the trailer from the PTO hydraulic power unit before service and maintenance
11. Stay away from any oil leaks
12. Turn off the PTO hydraulic power unit before moving the trailer
13. Keep clear at all times.

EMERGENCY STOP

In the event of an **EMERGENCY**, operation of the Cargo Floor system can be halted as follows:

- ◆ By pressing the red stop button on one of the control switches;
- ◆ By turning all switches to position “0”;
- ◆ By putting the handle of the control valve in the middle “0” position (only B and A control);
- ◆ Turning off the PTO pump/engine;
- ◆ Turning off the main switch of the power supply;
- ◆ Turning off the motor of the electro-hydraulic aggregate;

START UP CHECK LIST FOR OPERATION (UNLOADING / LOADING)

1. Check surroundings, at all times, that no persons, animals or objects are in the direct vicinity of the vehicle.
2. Open doors first.
CAUTION when opening the doors. There could be backpressure from the product to the doors which could force the doors to open themselves and injure you, also product could fall on top of you!
3. Check if hydraulic hoses/couplings are connected correctly and firmly (pressure and return).
4. Turn on the pump
5. Turn on the lights of the trailer
6. Check your operation: A, page 18 B page 21 or E page 28?
7. Determine/choose your required operation: unloading or loading. CAUTION check immediately if your required operation is working correctly.
8. During unloading it might be necessary to move the vehicle forward to achieve a faster and cleaner unloading.

Remarks!

- Make sure that your unloading / loading spot is long/large enough to move your complete vehicle its full length forward.
- The (hand)brake of the vehicle must always be applied.

STICKERS

This WARNING STICKER/DECAL has been supplied with the drive unit in two fold. It should be attached near the control box and on the rear door in such a way that it is easy to read.

STICKERS/DECALS ON THE TRAILER:
A

Eng **CAUTION CAUTION**

Important tips before the Cargo Floor system can be put into operation:

- Always consult the operation manual first.
- Always determine and check the direction of transport.
- People must always maintain a distance of at least 10 metres from a working Cargo Floor system.
- After use, always switch the Cargo Floor system back to the non-activated neutral (0) position.
- By maintenance work, switch off everything and disconnect the Hydraulics.

D **Wichtige Anweisung vor der Inbetriebnahme des Cargo Floor Systems:**

- Immer erst die Bedienungsanleitung lesen.
- Zuerst immer die gewünschte Transportrichtung bestimmen und kontrollieren.
- Vom aktivierten Cargo Floor System müssen Personen mindestens 10 Meter Abstand halten.
- Nach dem Einsatz des Cargo Floor System in die nicht aktivierte, neutrale Null-Stellung (0) zurücksetzen.
- Bei **Wartungsarbeiten**, alles ausschalten und die Hydraulik abkuppeln.

NL **Belangrijke aanwijzing voordat het Cargo Floor-systeem in gebruik mag worden genomen:**

- altijd eerst de bedieningshandleiding raadplegen.
- altijd eerst de gewenste transport richting bepalen en controleren.
- Personen moeten altijd tenminste 10 meter afstand houden van een werkend Cargo Floor systeem.
- Na gebruik altijd het Cargo Floor systeem in de niet geactiveerde neutrale (0) positie terugzetten.
- Bij **onderhoudswerkzaamheden**, alles uitschakelen en de hydrauliek loskoppelen.



KEEP CLEAR AT ALL TIMES !!



CARGO FLOOR®
HORIZONTAL LOADING-/UNLOADINGSYSTEM
www.cargofloor.com



Fr **CAUTION CAUTION**

Indications importantes avant de pouvoir utiliser le système Cargo Floor:

- Commencez toujours par consulter le manuel d'utilisation.
- Commencez toujours par déterminer et contrôler la direction de transport souhaitée.
- Tenez-vous toujours à au moins 10 mètres de distance d'un système Cargo Floor en fonctionnement.
- Après utilisation, remettez toujours le système Cargo Floor en position neutre (0) non activée.
- Pour tous travaux de maintenance, tout déconnecter et débrancher l'hydraulique.

Esp **Instrucciones importantes a seguir antes de poner en funcionamiento el sistema Cargo Floor:**

- Siempre consulte primero el manual de instrucciones.
- Siempre determine y controle primero el sentido de transporte deseado.
- Cuidé de que las personas siempre se mantengan a por lo menos 10 metros de distancia de un sistema Cargo Floor en movimiento.
- Una vez concluida la operación, siempre retorne el sistema Cargo Floor a las posiciones neutrales no activadas (0).
- Por trabajos de mantenimiento, apagar todo y desconectar los hidráulicos.

It **Instruccioni importanti a seguir anles de poner en funzionamento el sistema Cargo Floor:**

- Sempre consulte primo el manual de istruzioni.
- Sempre deternane y controle primo el sentido de transporte deseado.
- Cuidé de que las personas sempre se mantengan a por lo menos 10 metros de distancia de un sistema Cargo Floor en movimento.
- Una vez concluida la operación, siempre retorne el sistema Cargo Floor a las posiciones neutrales no activadas (0).
- Por trabajos de mantenimiento, apagar todo y desconectar los hidráulicos.



KEEP CLEAR AT ALL TIMES !!



CARGO FLOOR®
HORIZONTAL LOADING-/UNLOADINGSYSTEM
www.cargofloor.com



B

White/transparent



Black/ transparent



or

THE CARGO FLOOR MOVING FLOOR PRINCIPLE

The Cargo Floor 'moving floor' System is a multi-functional, horizontal loading and unloading system for the fast and efficient transport of almost any product. The system is ideal for unloading a wide variety of bulk products, which typically are loaded from above and unloaded horizontally from the rear by the Cargo Floor 'moving floor' System. It can also be used to load and unload packed materials

Step 1: three hydraulic cylinders move the entire floor as a whole in the selected direction, thereby transporting the cargo

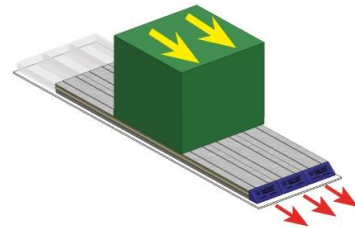

Step 2: one hydraulic cylinder pushes one group of floor profiles (= 1/3 floor section) back underneath the cargo, while 2/3 of the floor section remains still, the cargo will hardly move as a result

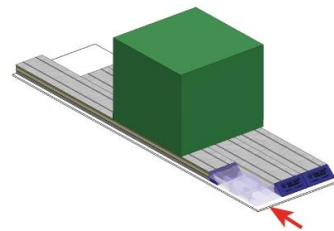

Step 3: one hydraulic cylinder pushes one group of floor profiles (= 1/3 floor section) underneath the cargo, while 2/3 of the floor section remains still, the cargo will hardly move as a result

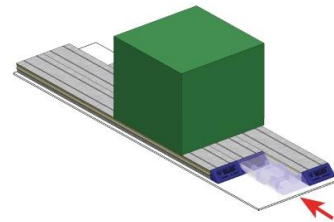

Step 4: one hydraulic cylinder pushes the third and last group of floor profiles (= 1/3 floor section) underneath the cargo, while 2/3 of the floor section remains still, the cargo will hardly move as a result

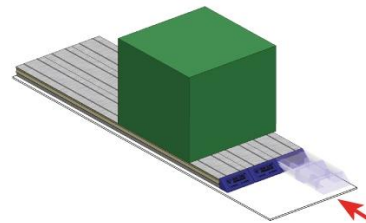

Step 1 is repeated again. The frequency and thus the speed at which these steps are repeated depend on the output of the hydraulic pump. The available power at which the cargo can be moved depends on the available pressure of the hydraulic pump. The Cargo Floor 'moving floor' System is designed for a maximum payload of 44 us tons.

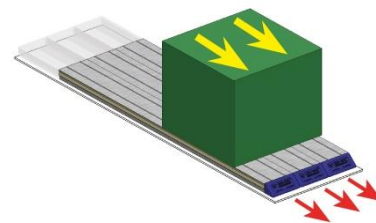

The principle works in two directions, in other words the Cargo Floor 'moving floor' System can be used to LOAD and UNLOAD.

MODULAR OPERATING POSSIBILITIES

Thanks to its modular construction, the following operative versions of the Cargo Floor 'moving floor®' system are possible (also retrofittable):

A control



A-control with loading / stop / unloading over a manual handle, with unique "S" detent mechanism in order to determine loading / stop / unloading position. (Non-electrical.)

B control



STANDARD



OPTIONAL



B-control with loading / stop / unloading over a manual handle, with unique "S" detent mechanism in order to determine loading / stop / unloading position. on / off switching over a switch.
 As a standard provided with a manual override by means of a unique red "Cargo" rotary switch.
 (Optional: radio remote control.)

E control



Manual override by means of a unique red "Cargo" rotary switch.

STANDARD



OPTIONAL



E-control with loading / stop / unloading over a switch
 As a standard provided with a manual override by means of a unique red "Cargo" rotary switch.
 (Optional: radio remote control.)

WET KIT INFORMATION

This wet kit is designed to be used with most transmissions. Power Take Off (P.T.O.) specifications may vary with some transmissions. Please check with your supplier for specific applications.

The wet kit used to power the Cargo Floor system must comply with the following specifications:

	CF500 SLC	CF100 SLC	CF500 SLC Power Speed	CF3 LP-2	CF600 HDC	CF800
Advised pump capacity (l/min [gpm])	110 [29]	70 [18]	180 [48]	110 [29]	110 [29]	110 [29]
Max. Pump capacity (l/min [gpm])	130 [34]	80 [21]	200 [53]	170 [45]	190 [50]	130 [34]
Max. Pressure relieve valve *bar [psi]	250 [3,625]	200 [2,900]	250 [3,625]	175 [2,538]	220 [3,191]	250 [3,625]

*Pressure relieve valve must have the ability to relieve the full pump flow at the maximum pressure for the system.

PRINCIPLE WET KIT DIAGRAM

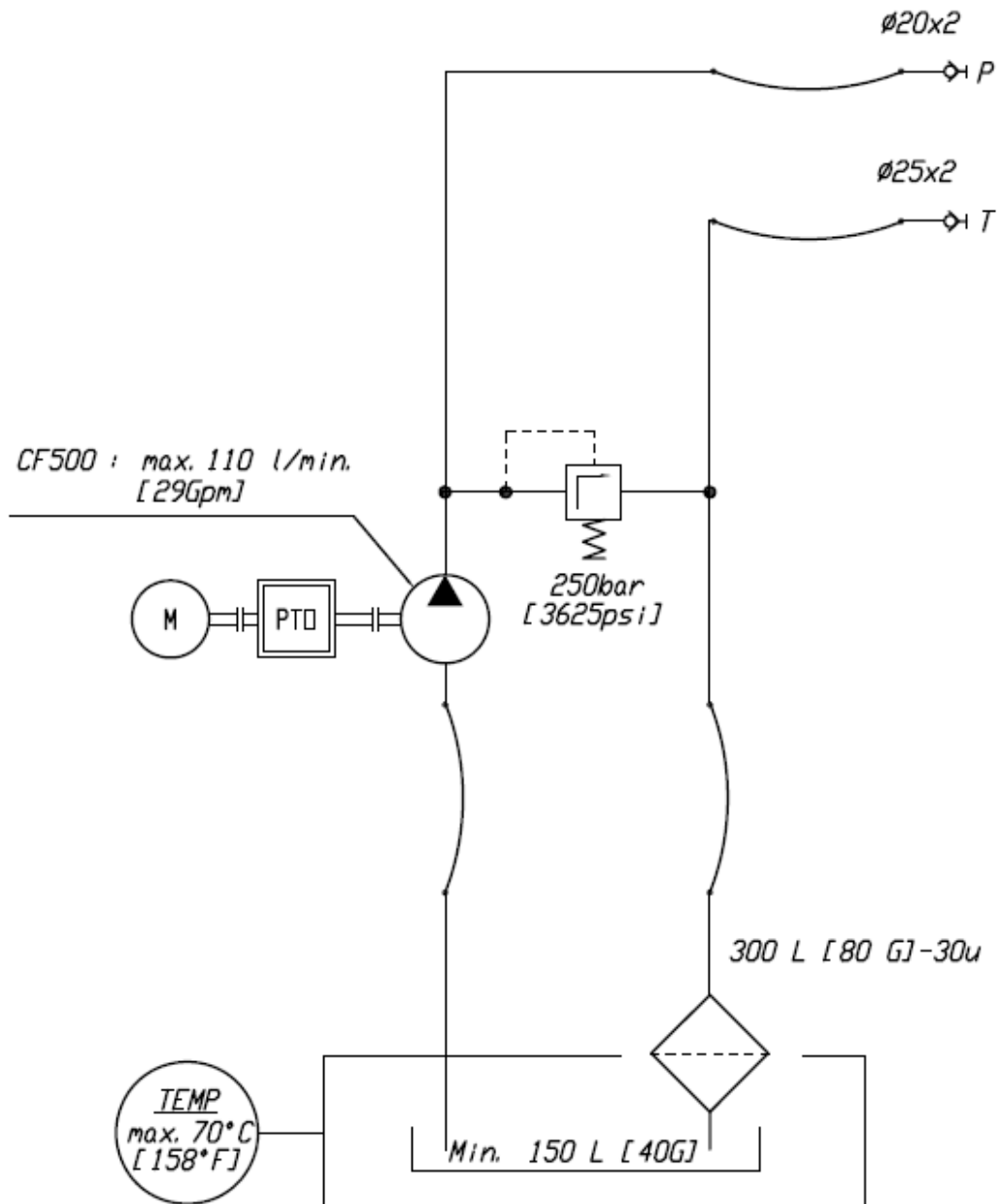

Oil: See “hydraulic recommendations”.

Pump: All gear pumps regardless of make or model should be "run in" as per manufacturer's recommendations before connecting to the trailer for the first time.

Return filter: Filter should be 10 to 30 micron on the return line. Filter should be mounted as close to the reservoir as possible. Return filter elements should be changed after 6 hours initially and every 6 months thereafter.

Hydraulic Reservoir: Should hold approximately 1 liter [1 gallon] of oil for every liter [gallon] per minute of pump output. (110 l/min [29 gpm] pump = minimum 110 liter [29 gal] reservoir)

Suction line: Hydraulic suction line with a 50 mm [2"] inside diameter, not more than 1500 mm [5'] long

Pressure line: All pressure lines should be minimum diameter of 20x2 mm [3/4"]

Return line: all hoses and lines should be a minimum diameter of 25x2 mm [1"]

Pressure relief valve: Must be pilot operated type, and sized correctly for the system. See wet kit specification.

Hydraulic recommendations

1. Use ISO 22 grade oil if the minimum operating temperature is between -25 and 0 °C [-13 and 32 °F].
 2. Use ISO 32 grade oil if the minimum operating temperature is between -15 and 30 °C [5 and 86 °F].
 3. Use ISO 46 grade oil if the operating temperature range is between 15 and 40 °C [59 and 104 °F].
- Note: The suggested maximum viscosity value for start-up is 1000 cSt.

Temperature below -25 [-13 °F] degree Celsius

Use the following warm up procedure in temperatures below -25 degrees Celsius [-13°F]:

1. Set the operation handle for unload (1) – 0 – load (2) in the middle 0-position
2. Circulate the oil for a few minutes to preheat it and lower its viscosity.

Less than -25 °C [-13°F]	-25 - 0 °C [-13 – 32 °F]	-15 - 30 °C [5 – 86 °F]	15 - 40 °C [59-104 °F]
Warm up	ISO 22	ISO 32	ISO 46

HYDRAULIC START-UP CHECK LIST FOR THE CARGO FLOOR SYSTEM

Before starting your new CARGO FLOOR unloader, a quick start-up check should be made

1. **Hydraulic:** is your entire system plumbed to the plumbing diagram?
2. ***Pump:** Will it pump the advised flow at the maximum pressure according to the system?
3. ***Relief Valve:** is it set at the maximum pressure according to the system?
4. **Hydraulic reservoir:** Is it big enough and filled?
5. **Power Take Off:** Is the P.T.O. engaged?
6. **Hoses:** Is the pressure line on the trailer attached to the pressure line on the tractor and the return line on the trailer attached to the return line on the tractor?
7. **Quick Disconnects:** are these suitable and connected the right way?
8. **Controls Cargo Floor:** Operation handle unload (1) - 0 - load (2) in position 0?

*If the information about your pump and relief valve is not known, a pressure/flow check will help determine this information. Be sure that your entire wet kit system meets the requirements of the hydraulic wet kit specifications in this manual.

IDENTIFICATION PLATE

Attention! With all communications we will ask for the system number. Fill out your system number here to have it present at all times:.....

 CARGO FLOOR® HORIZONTAL LOADING-/UNLOADINGSYSTEM		Cargo Floor B.V. Byte 14, NL-7741 MK Coevorden www.cargofloor.com	
Type	CF500 SL-C	Max.WP.	225bar [3,300 psi]
Product	MOVING FLOOR®	Max.CAP.	40t [88,000lbs]
System no.	123456		
CF SO.			
Client PO.			
Manufacturers of the CARGO FLOOR® selfloader and self-unloader World wide PATENTS pending!			

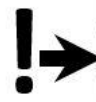
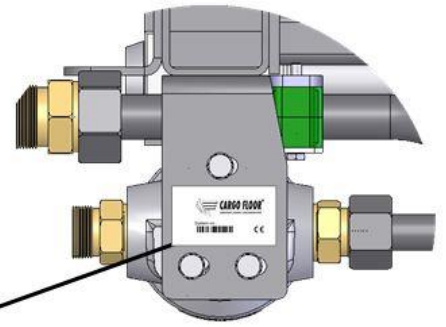

 CARGO FLOOR® HORIZONTAL LOADING-/UNLOADINGSYSTEM	
System no.:	123456
	
	

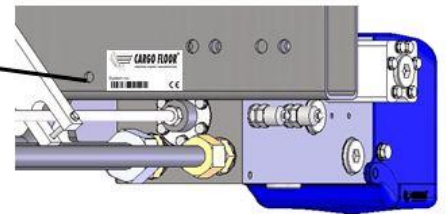
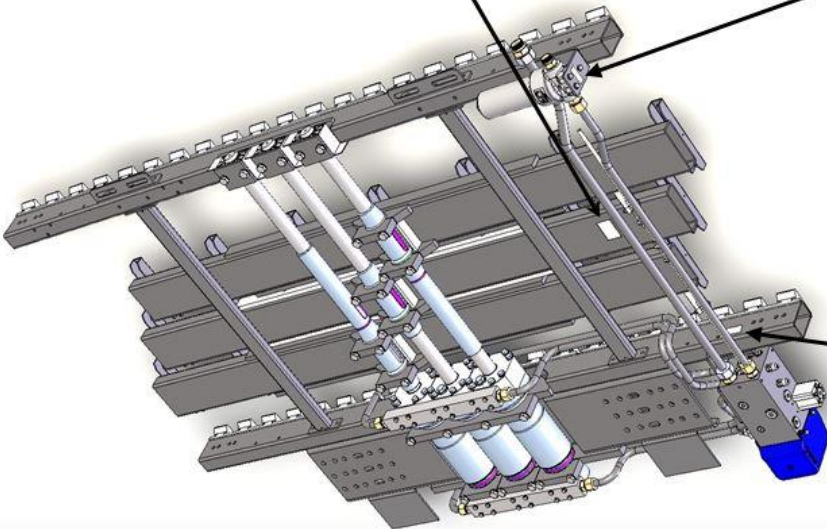

 CARGO FLOOR® HORIZONTAL LOADING-/UNLOADINGSYSTEM	
System no.:	123456
	

 CARGO FLOOR® HORIZONTAL LOADING-/UNLOADINGSYSTEM	
Type	CF500 SL-C
Product	MOVING FLOOR®
System no.	123456
CF SO.	123456
Client PO.	123456
Manufacturers of the CARGO FLOOR® selfloader and self-unloader World wide PATENTS pending!	

CARGO FLOOR TECHNICAL SPECIFICATIONS

	CF500 SLC	CF100 SLL	CF500 Power speed	CF3 LP-2 (leak proof)	CF600 HDC	CF800 HD-6
Bore (mm [inch])	100 [3.9]	80 [3.15]	100 [4]	125 [4.9]	120 [4.7]	100 [3.9]
Piston rod diameter (mm [inch])	45 [1.77]	35 [1.38]	45 [1.77]	60 [2.35]	45 [1.8]	50 [2]
Stroke (mm [inch])	200 [8]	150 [5.9]	200 [8]	150 [5.9]	200 [8]	200 [8]
Cylinder volume ltr. [gallon]	2,82 [0.7]	1,36 [0.4]	2,82 [0.75]	3,26 [0.9]	4,2 [1.1]	5,5 [1.5]
Oil volume per cycle (ltr. [gallon])	8,46 [2.2]	4,09 [1.1]	8,46 [2.25]	9,77 [2.6]	12,6 [3.3]	16,5 [4.4]
Pressure relief valve setting, max. pressure (bar [psi])	225 [3,300]	175 [2,538]	225 [3,300]	150 [2,175]	205 [2973]	225 [3,300]
Strokes per minute with advised pump capacity	13	17	21	11	8,7	6,6
Speed (mtr. / min [ft./min]) with advised pump capacity	2,6 [8.5]	2,6 [8.5]	4,2 [13.8]	2,0 [6.6]	1,7 [5.6]	1,3 [10]
Advised pump capacity: Flow (ltr./min [gpm])	110 [29]	70 [18.5]	180 [47.6]	130 [34]	110 [29]	110 [29]
Pressure (bar [psi])	250 [3,625]	200 [2,900]	250 [3,625]	175 [2,538]	205 [2973]	250 [3,625]
Max. pump capacity: Flow (ltr./min [gpm])	130 [34.5]	80 [21]	200 [52.8]	170 [45]	190 [50]	130 [34.5]
Pressure (bar [psi])	250 [3,625]	200 [2,900]	250 [3,625]	175 [2,538]	205 [2973]	250 [3,625]
Speed at maximum pump capacity (mtr. / min. [ft./min])	3,1 [10]	2,9 [9.5]	4,7 [15.4]	2,6 [8.5]	3,0 [9.8]	1,6 [5.2]

Solenoid/coil; 24V DC only E and B control (optional available 12 V DC)

Pressure filter type; high-pressure 10 micron (part no. 7372005)

Estimated unloading table

Engine	Pump output	speed*	Unloading time 13.6 mtr [45 ft] trailer
550 RPM/m [rpm]	60 l/m [15 g/min]	1.4 m/min [4.6 ft/min]	9-10 minutes
750 RPM/m [rpm]	80 l/m [21 g/min]	1.9 m/min [5.9 ft/min]	7-8 minutes
1000 RPM/m [rpm]	110 l/m [29 g/min]	2.6 m/min [8.5 ft/min]	5-6 minutes

*Above specifications are for a Cargo Floor CF500 drive unit with 100 mm [3.9"] bore cylinders. These only are approximate meters per minute and should strictly be used as a reference

MAINTENANCE INSTRUCTIONS

When works require turning on the floor you should take care of that the floor can be shut down immediately at any time. Places where clamping/clasping of body parts is possible may not be approached when the system is moving.

For more detailed explanation of the execution of the works we would like to refer you to our website: http://www.cargofloor.com/en/documents/en_downloads.

Check for the end user / owner after receipt of the new Cargo Floor trailer

Check a couple of days after receipt of the new trailer and / or after 10 loads / unloads and after one month the connection between the aluminium floor profiles and the Cargo Floor system. You do this by placing your finger half on the screw and half on the floor profile when the floor is operating.

Important: if you feel a difference in movement between the screw and the floor profile it means the floor profile is not fastened enough. The screw connection of the whole profile group this concerns needs to be renewed with new screws in accordance to the fastenings guidelines mentioned in the assembly instructions (see www.cargofloor.com, downloads). Also the countersunk hole needs to be cleaned properly. Do not check the screw connections with the help of a allen key and do not simply just tighten the screws, the Loctite connection will be broken.

Specifications of the screws:

M12 x 30 countersunk screws with hexagon socket, class 10.9, galvanized. DIN 7991 (dacromet). The torque is 100 – 140 Nm [72 – 105 lbf.ft.]

Regular checks and preventive maintenance:

To ensure that your Cargo Floor system operates reliably and has a long life, it is important that you regularly perform careful checks on the following aspects:

- Replace the filter element every year, or more often if needed
- Change the oil every 2 years, or more frequently if required;
- The level of oil in the tank. See for oil levels and the oil specifications the wet kit information
- Floor profiles: are they still fixed, replace screws if necessary!
- Check the guide blocks for the 3 piston rods for wear
- Check the coupling nuts and couplings of all hydraulic components, and adjust if necessary!
- Oil tank: by taking the lid off the tank, you can remove any remains (condensation, dirt etc.) from the bottom.
- Return-/pressure filter: by removing the filter lid/chamber you can check the filter element, or after about one year replace it.
- Check the seal between the two fixated floor profiles and the moving profiles. If a margin exist in between, then adjust the fixated floor profiles, in order for the sealing to be optimal and leakage via the side walls is prevented.

This is all necessary to avoid internal wear (of the pump/cylinders etc., for example).

New filter parts are available at your system builder. For the right type we refer you to our “exploded views” which you can find on our website: http://www.cargofloor.com/en/documents/en_downloads.

We want to emphasize that the minimal costs of replacing dirty parts or oil do not match the costs and discomfort that can arise.

- Adjusting the threaded rod of the control valve;
It is important that the steering valve is correctly adjusted and that the switchover moment occurs according to the procedures.

ADJUSTMENT OF THE THREADED ROD OF THE CONTROL VALVE

Front side trailer

Rear side trailer

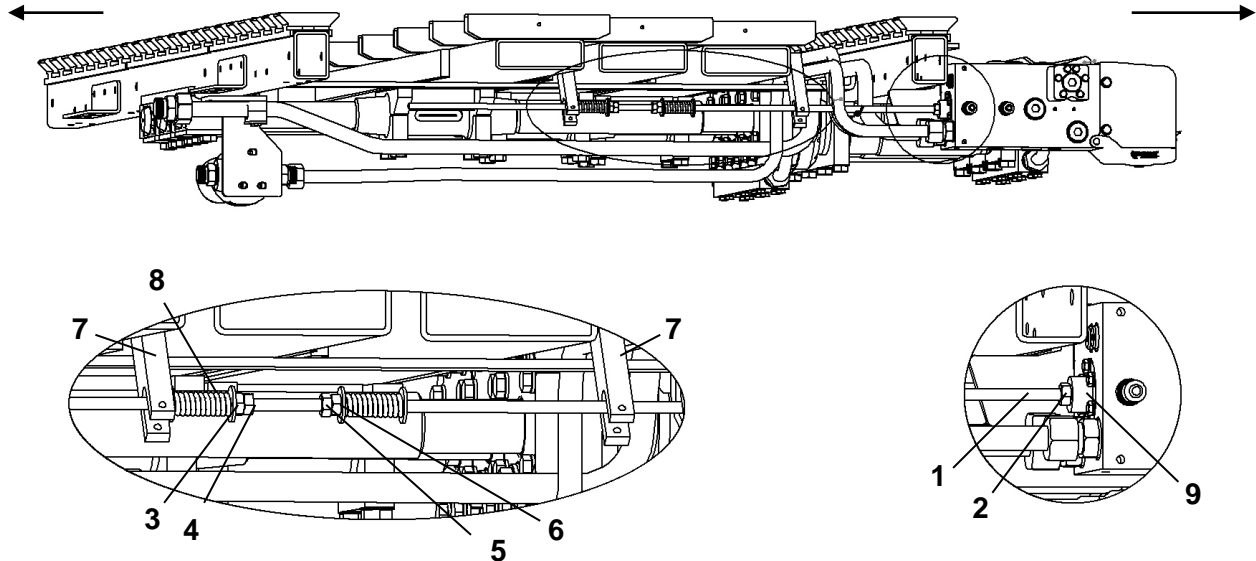

All Cargo Floor systems have the threaded rod set and are fully tested. You therefore do not need to adjust the threaded rod, but in certain circumstances (f.e. certain repairs) it may be necessary to check or adjust the setting of the threaded rod. If switching spontaneously doesn't go normally anymore, then please make a good assessment first why this has happened.

Attention:

The pump and electrical installation must always be switched-off when working on the system; in addition, the hoses and/or pipelines between the pump and the Cargo Floor should also be disconnected. If not the risk of entrapment arises!!!

Necessary tools:

- 2x spanner 17;
- High viscosity oil;
- Copper grease;
- Steel brush.

Check that the threaded rod (1) is fastened securely to the switching valve, with pressing and pulling the stroke is exactly 12 mm. [0.5"].

If not, then screw the threaded rod (1) as far as possible into the plunger and secure this with the contra nut (2) (spanner size 17). Loosen nuts (3 and 4, spanner size 17) and move these about 3 cm [1.25"] in the direction of the rear of the trailer.

Now switch the pump on while you are at a safe distance. The system will start to move and stops automatically at the point where the command lip (7) no longer operates the switching valve, because the spring (8) is no longer pushed. Switch off the pump immediately.

Now push the threaded rod (1) in the direction of the rear of the trailer until the spacer ring (9) touches the control valve.

Tighten nuts (3 and 4) so far in the direction of the front side of the trailer that the spring is fully pushed in, and secure them by tightening them against one another. Repeat this procedure for the other side (nuts 5 and 6) by doing everything in opposite directions.

N.B. It is worthwhile spreading some copper grease on the threaded rod (1).

WARRANTY CONDITIONS

Warranty shall only be given with the prior consent of Cargo Floor B.V.! With warranty requests always fill in and send a warranty request form to Cargo Floor B.V. beforehand. You can fill in a request for warranty simply on our website: http://www.cargofloor.com/en/site/en_garantieformulier.

The warranty conditions, as specified in the most recent "Metaalunie" conditions, filed with the registrar of the District Court of Rotterdam, are applicable in unabbreviated form. On request available.

A short extract of these conditions follows:

A warranty period of 12 months (starting directly after installation) applies for all Cargo Floor system materials supplied by us. In the case of malfunction and/or manufacturing faults we are only responsible for the costless supply of replacement parts, if:

- The warranty period is for the first equipment owner only.
- The Cargo Floor system is installed by your trailer builder according to our installation procedures.
- Our maintenance and control procedures have been followed.
- In the case of a malfunction, the system builder, or Cargo Floor have been informed

The following components are not covered by the warranty:

- Malfunction of equipment, or caused by equipment, which was not supplied by Cargo Floor.
- Malfunction caused by the use of dirty oil, or oil of the wrong type.
- Malfunction caused by overheated oil, T. max. ≤ 70 °C. [158 °F]
- Malfunction caused by overloading or injudicious use.
- Malfunction caused by improper repair work, or repair work which is carried out by third parties.
- Malfunction caused by corrosive materials
- Filter elements and components, which are subject to normal wear-and-tear and are not warranty items.
- Defects in electrical components due to incorrect connection and/or incorrect voltage levels.
- Consequential damages

The warranty is void if:

- The system is used for purposes, which have not been recommended by Cargo Floor
- The wet kit is not as recommend in the Cargo Floor manuals
- The Cargo Floor system is not installed properly
- Load in excess of legal limit are moved as defined in Cargo Floor manuals and operating instructions.
- The Cargo Floor system has not constructed correctly by your trailer builder, insofar as this has a negative influence on the operation of the system.

Cargo Floor hereby warrants, only to the first owner of a new Cargo Floor unloader from the factory or selling distributor, that the Cargo Floor hydraulic parts and hydraulic components shall be warranted as free from defects in material and workmanship for a period of one year to the first registered owner from the date of the sale.

This warranty does not cover normal wear and tear, maintenance, or heat damage. It is not to be construed as a service contract.

Note: Prevention of excessive heat in the hydraulic system is the single most important factor for long system life. Bad pumps, improper wet kits and hydraulic restrictions cause excessive heat and will damage the hydraulic system. Heat damage will void the warranty.

Definition of normal use and service:

Normal use and service means the loading and/or unloading of uniformly distributed, non-corrosive material, properly restrained and secured, on properly maintained public roads, with gross vehicle weights not in excess of factory rated capacity.

Sole and exclusive remedy:

If the product covered hereby fails to conform to the above stated warranty, **Cargo Floor** sole liability under this warranty and the owner's sole and exclusive remedy is limited to repair or replacement of the defective part(s) at a facility authorized by your dealer or **Cargo Floor**. This is the owner's sole and exclusive remedy for all contract claims, and all tort claims including those based on the strict liability in tort and negligence. Any defective part(s) must be shipped freight prepaid to your dealer who will contact **Cargo Floor**

Except as expressly set forth above, Cargo Floor makes no warranties:

Express, implied or statutory, specifically: No warranties of fitness for a particular purpose or warranties of merchantability are made. Further, **Cargo Floor** will not be liable for incidental damages or consequential damages such as, but not limited to, loss of use of the product, damage to the product, towing expenses, attorney's fees and the liability you may have in respect to any other reason.

Tort disclaimer:

Cargo Floor shall not have any liability in tort with respect to the products, including any liability based on strict liability in tort and negligence.

If this warranty violates law:

To the extent any provision of this warranty, contravenes the law of any jurisdiction, that provision shall be inapplicable in such jurisdiction and the remainder of the warranty shall not be affected thereby.

A-CONTROL

Control with loading / stop / unloading over a manual handle, with unique "S" detent mechanism in order to determine loading/stop/unloading position. Non electrical.

CONTROL VALVE

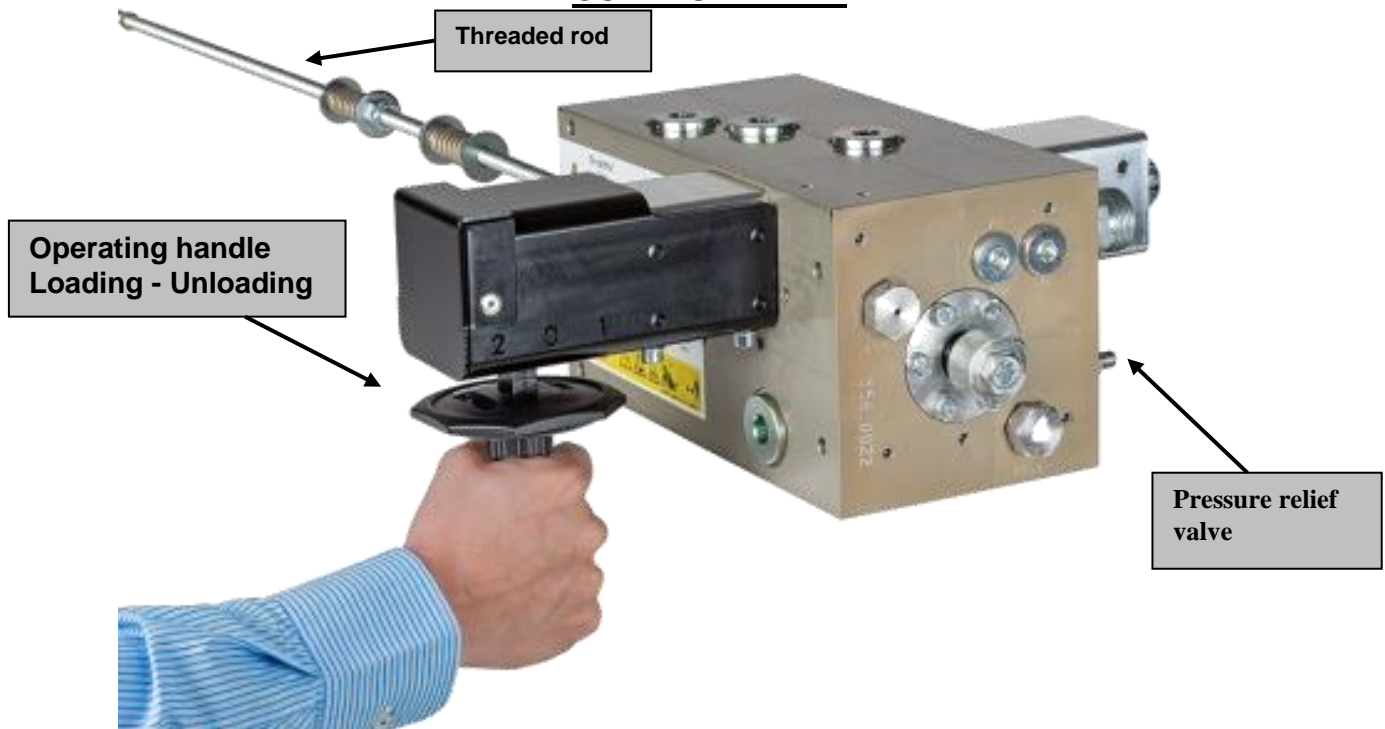

Systems fitted with A-control do not include any electrical operation. The system will begin to move depending on the position of the operation handle on the control valve. The handle should be positioned, before and after using the Cargo Floor, in the position stop (0) if the handle is in the position 1 or 2 the system immediately starts to move when the pump/ PTO is activated.

LOADING – UNLOADING FUNCTION

The position of the handle:

1 handle pushed in; floor will unload



0 handle in the middle position; floor stops



2 handle pulled out; floor will load

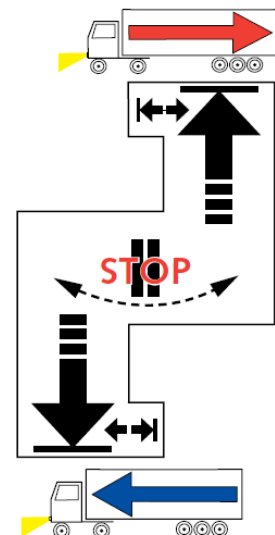

WARNING ! SWITCHING ON THE PUMP/PTO COULD START THE FLOOR MOVING!

HYDRAULIC CIRCUIT DIAGRAM A-CONTROL

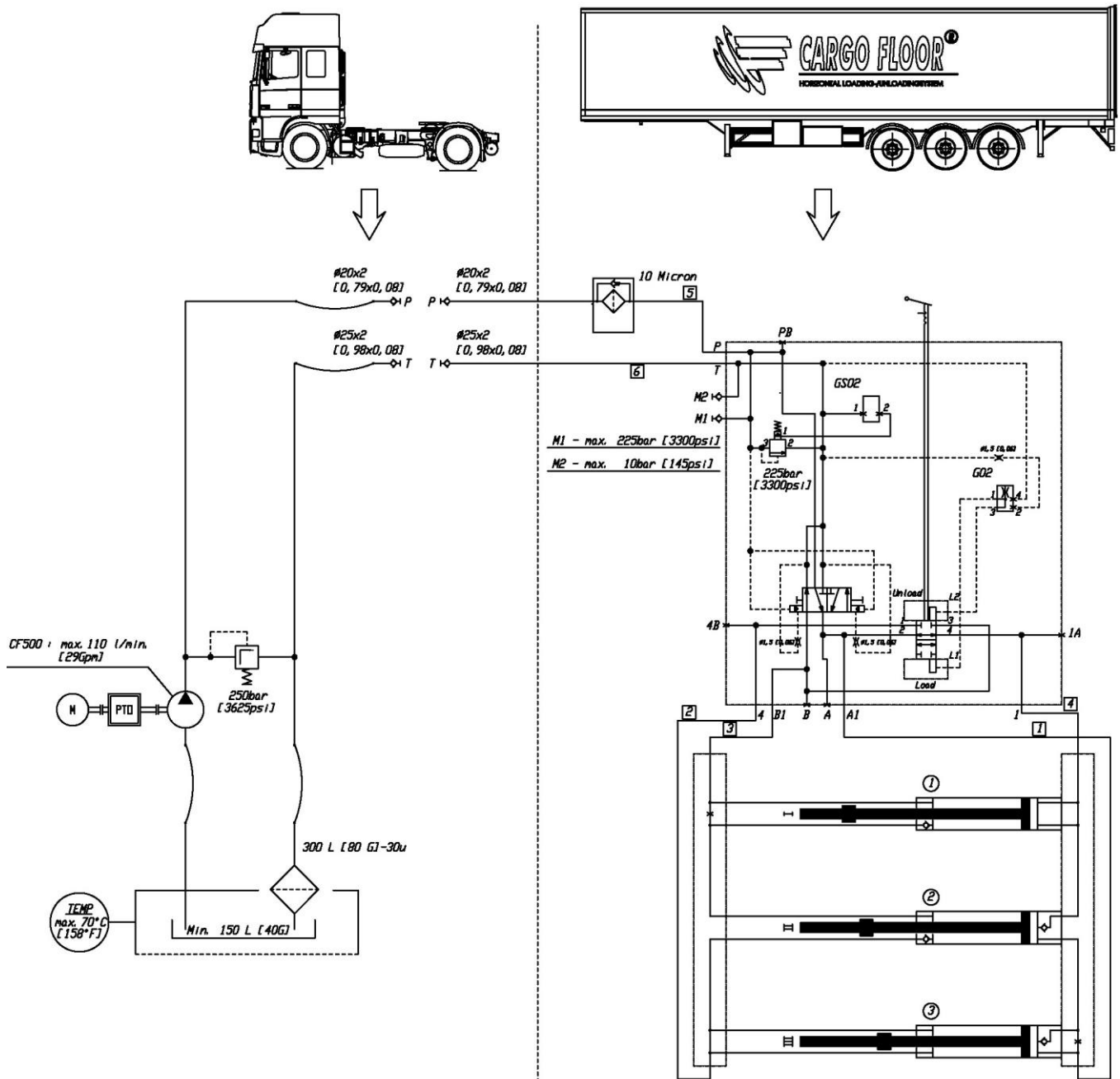

TROUBLESHOOTING A-CONTROL VALVE

In the event of the failure of the Cargo Floor system to operate (in the correct manner) when used in accordance with the operating instructions carry out the following checks:

Malfunction system	Concerns part	Cause	Solution
1. Does not operate No oil flow control valve	PTO	Not switched on	Switch on PTO
	Quick coupling	Blockade	Check couplings / mount correctly
2. Does not operate There is oil flow control valve	Pressure control valve	Polluted	Clean / replace, attention: do not open the pressure control valve in parts
	Operating handle	Is in the middle position	Move the handle in the direction of loading/unloading
3. Individual movement is difficult and/or incorrect with a full trailer	Pressure control valve	Tipper valve	Turn tipper valve in correct position
		Pressure control valve pulling vehicle max. pressure too low	Measure max. pressure/ adjust pulling vehicle
		Return oil has restrictions	Measure pressure M2, remove restrictions
	Capacity of the system is insufficient.	Too much load	Unload part of load with crane
		Pollution between the Floor profiles	Clean
		Frost	Thaw
4. Individual movement is incorrect when unloading With a full and empty trailer	Valve in cylinder head 1 or 2	Pollution prevents a good connection	Remove pollution
		Broken valve spring	Replace spring
	Valve seat in cylinder head 1 or 2	Valve seat has loosened	*Replace / fasten valve seat
		Common rail cylinder rod side	Stop in the common rail has loosened
	Common rail mounted the wrong way around		Mount common rail correctly
5. Switching is difficult or goes not at all. 3 Cylinders are fully retracted or fully out.	a. Threaded rod	Adjustment incorrect	Adjust correctly, attention: determine cause. See: b. and c.
		Switching spring broken	Replace spring, attention: determine cause. See: b. and c.
	b. Switching plunger	Stroke > 12 mm. [0.5"] -> threaded rod loose, spacer loose	Screw in threaded rod / bolt fully.
	c. moving cross member	Slanting caused by loose profiles	*Replace screws and provide them with a thread locking product and check the rod bearing.
	d. Switching choke	Polluted	* Clean choke
6. Other malfunctions	Please contact your trailer builder or Cargo Floor, keep the system number at hand.		

*Contact your trailer builder or Cargo Floor for a repair advise.

B-CONTROL

Control with loading / stop / unloading over a manual handle, with unique "S" detent mechanism in order to determine loading / stop / unloading position. On / off switching over a switch.

As a standard provided with a manual override by means of a unique red "Cargo" rotary switch. (Optional: radio remote control.)

CONTROL VALVE

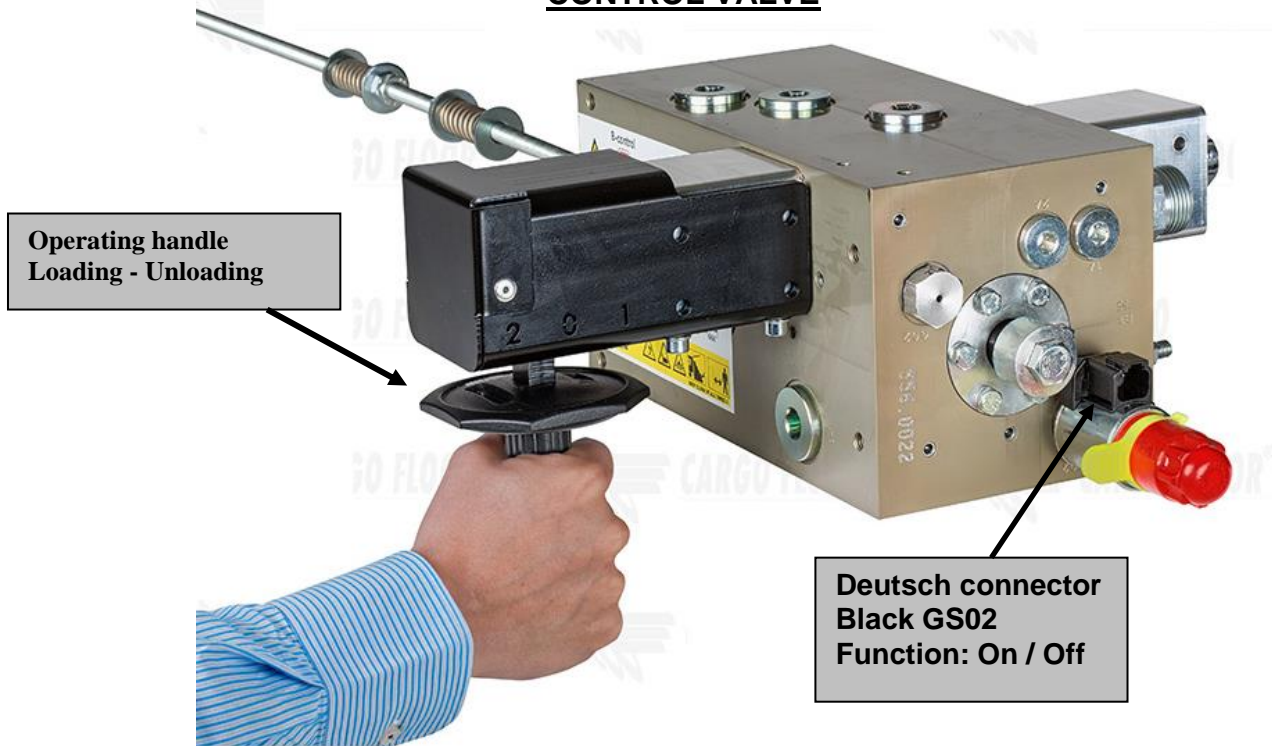

LOADING – UNLOADING FUNCTION

The loading or unloading modes can be selected using the handle located on the control valve, see the illustration.

The position of the handle:

1 handle pushed in; floor will unload



0 handle in the middle position; floor stops



2 handle pulled out; floor will load

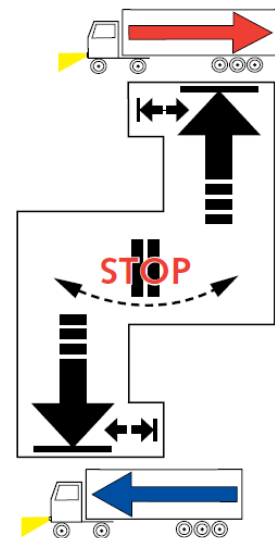

FUNCTION OF B-CONTROL SWITCHES

CF3 SWITCH

The CF3 switch is the permanent switch which is mounted in the control box and has 3 switch positions with the following functions:



Middle position= 0

The rotary switch automatically returns to this position when the switch is released.

→ = **ON**

From this position the switch will go back to the stop position when released.

← = **ON**

From this position the switch will go back to the stop position when released.

In the interest of safety this switch is fitted with an automatic spring-back for position I and II, so that it always returns to "0" position. This is necessary to prevent conflict situations arising when using the CF 4 remote control.

Mounted below the CF3 switch, is a connector to which the CF4 switch or the RX RECEIVER can be connected without the need for any adjustments.

Normally, the CF3 switch should only be used if the CF4 switch is defective.

If, after the initial assembly, the switch does not work it is probably because the connections for the + (brown) and the - (blue) have been swapped around. The supply cable contains a blocking diode which prevents damages arising from the + and - from being connected in reverse.

A 2 Amp fuse has been mounted in the CF 3 switch. Never mount a fuse over 3A, this can cause damage to the electrical installation

CF 4 SWITCH (MAIN CONTROL)

The standard supplied remote control CF4, with 10 meter [30'] of cable, is used for the day-to-day control of the system.

The CF 4 switch has the following buttons:



Red button: the stop button. This is activated by pushing it in and deactivated by turning it;

Rotary switch. This is a rotary switch with three positions. Activating this switch the system will, depending on the position of the operational lever, start loading or unloading. When this switch is deactivated the system stops.

Middle position = **STOP**

→ = **ON**

In this position the switch will stay in the position (position lock).

← = **ON**

From this position the switch will go back to the stop position when released.

The CF4 switch has a plug connector, which can be inserted into the connector of the CF3 switch and screwed tight.

To disconnect this, the duct must be unscrewed, after which the plug can be pulled out. Normally, this plug should always be connected to the connector.

OPTIONAL

A radio controlled remote control is available as an option.
 This incorporates:

CF RX Receiver

which has a plug connector which can be inserted into the connector of the CF3 switch and screwed tight. To disconnect this the duct must be unscrewed, after which the plug can be pulled out. Normally, this plug should always be connected to the connector.



Red stop button

On the receiver RX a red stop button is mounted, by pushing this button you can stop the system in case of emergency. By pulling it the system will be activated again. Do take care, with reference to the accessibility, that when using a remote control, the door of the control box is opened so the red stop button can be operated.

Tilting switch

This receiver is supplied with a tilting switch, with this switch can de system be activated. Above the tilting switch are three LED's, they indicate that the power supply is present and the chosen switching action.

CF TX remote control

Fitted with three control buttons with the following functions:



Button 1 (ON PULSE as pulse contact). By pushing this button the system will be activated, by releasing it the system will deactivate.

Button 2 (ON HOLD as hold contact). By pushing this button the system will be activated, by pushing it again the system will deactivate (or you push the stop button 3).

Button 3. (Stop) With this button you stop the system.

The red LED on the handheld remote flashes while the button is pressed.

MANUAL OVERRIDE B-CONTROL

In the event of a malfunction in the electrical system the electric valve can still be operated by activating the manual override fitted for that purpose.

MAKE SURE THAT THE DOORS ARE OPEN!

When using this manual override you must always ensure that it is after use always deactivated to the original non-activated position.

Activation of the manual override: ON

Remove the yellow security clip and turn in (clockwise) the red button on top of the on/off GS02 solenoid till the stop. The system will switch "on" when the operation handle is in the load or unload position.

Deactivation of the emergency controls: ON

Turn out (counter clockwise) the red button on top of the GS02 solenoid until the click and place back the yellow security clip. The system switches "off".

**On / off solenoid/coil
Not activated**

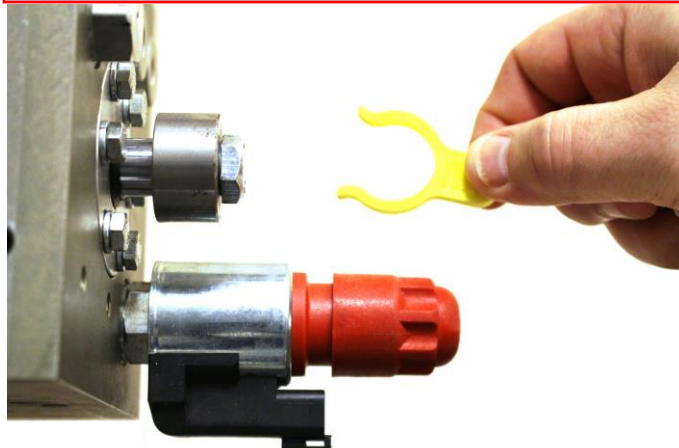

**On / off solenoid/coil
Manually activated**

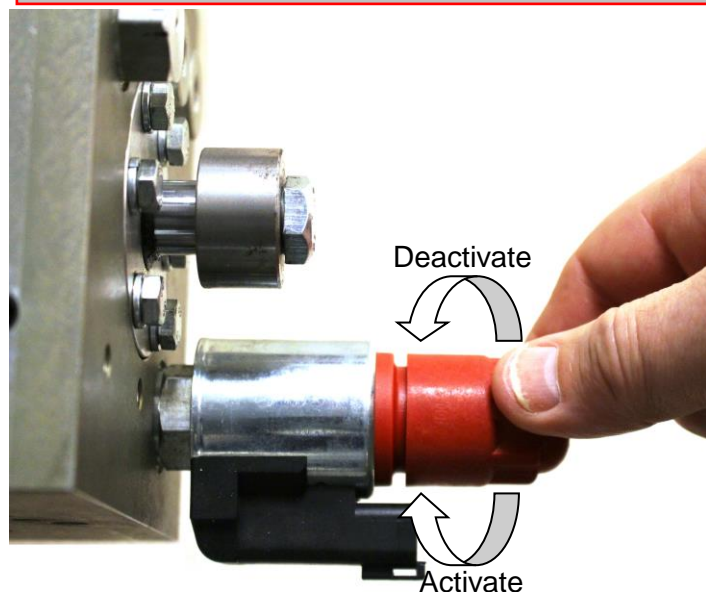

ELECTRICAL CIRCUIT DIAGRAM B-CONTROL

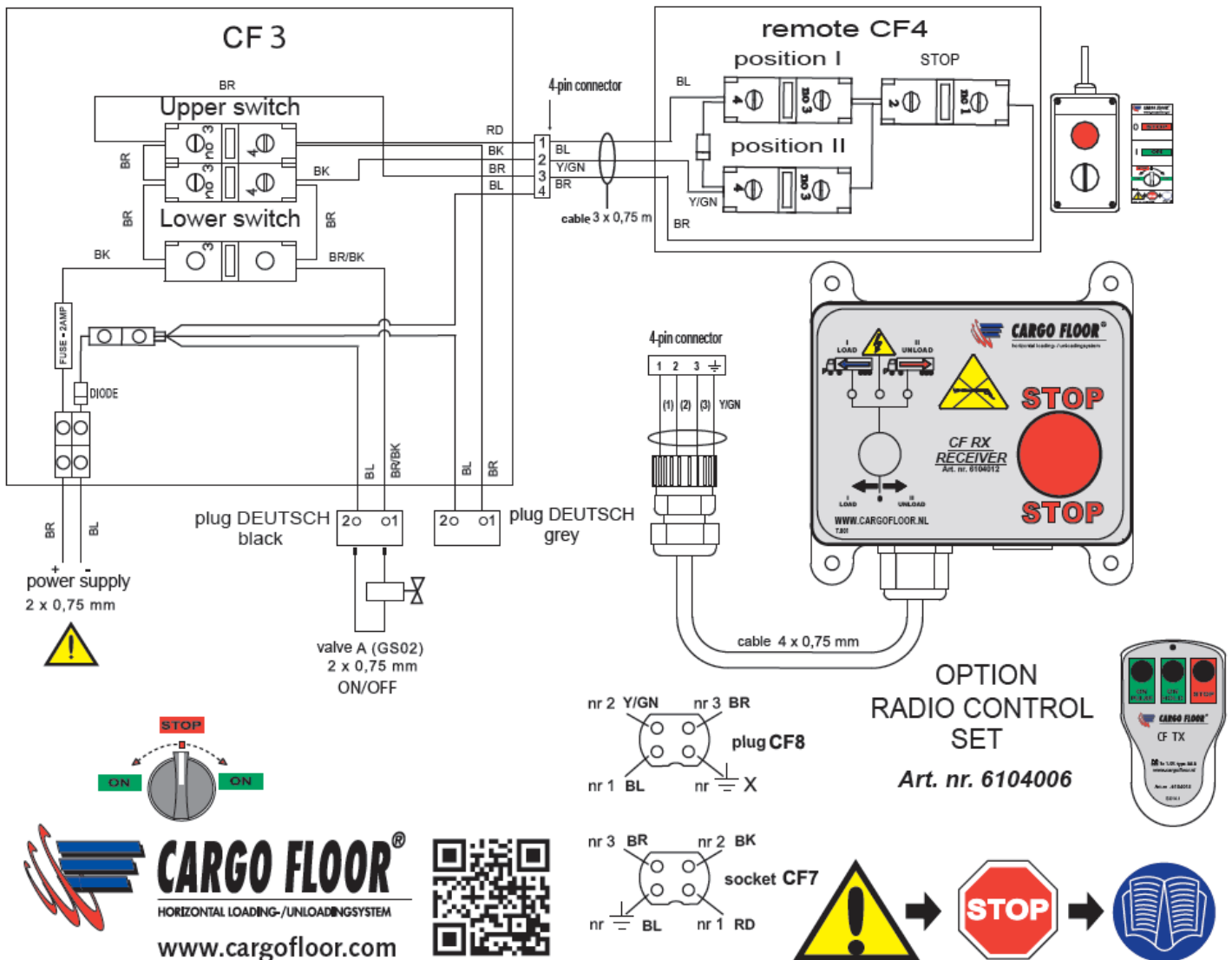

S.009-B.10-14

HYDRAULIC CIRCUIT DIAGRAM B-CONTROL

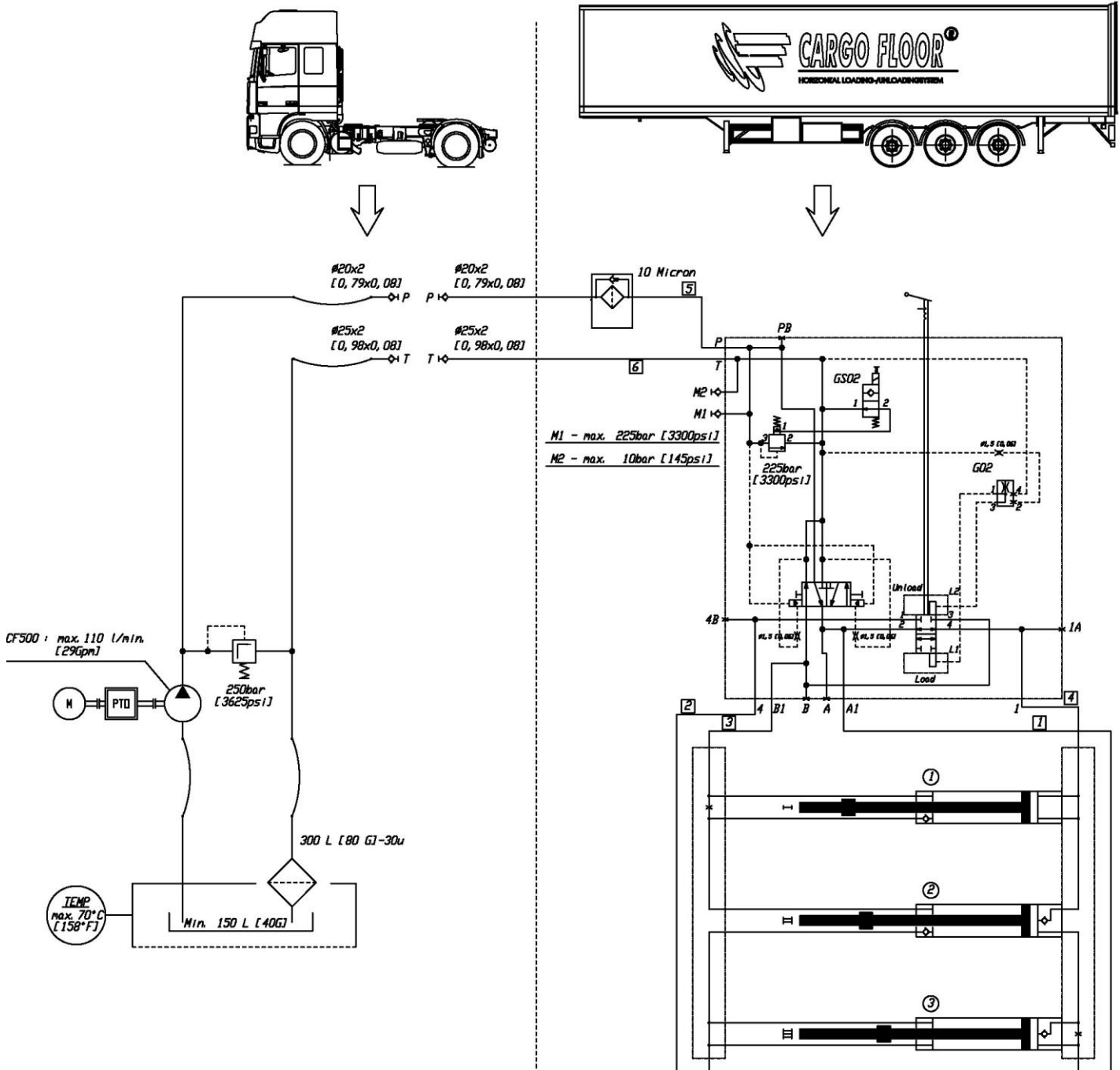

TROUBLESHOOTING B-CONTROL VALVE

In the event of the failure of the Cargo Floor system to operate (in the correct manner) when used in accordance with the operating instructions carry out the following checks:

Malfunction system	Concerns part	Cause	Solution
1. Does not operate No oil flow control valve	PTO	Not switched on	Switch on PTO
	Quick coupling	Blockade	Check couplings / mount correctly
2. Does not operate There is oil flow control valve	Remote control	Manual override operated	De-activate manual override
	Solenoid valve GS02 on/off	Interruption wiring Interruption in coil	Activate override GS02 temporarily and/or repair power supply
	Pressure control valve	Polluted	Clean / replace the pressure control valve. Attention: do not open the pressure control valve in parts
	Operating handle	Is in the middle position	Move the handle in the direction of loading/unloading
3. Starts immediately after switching on the PTO	Switch CF3	Switch movement blocked in the on position	Remove blockade
	GS02 on/of	Manual override activated	De-activate manual override, put yellow security clip back in place
	Hoses connected reversed	Pressure and return hoses where swapped	Check filter first, then connect pressure and return correctly.
4. Individual movement is difficult and/or incorrect with a full trailer	Pressure control valve	Tipper valve	Turn tipper valve in correct position
		Pressure control valve pulling vehicle max. pressure too low	Measure max. pressure/ adjust pulling vehicle
		Return oil has restrictions	Measure pressure M2, remove restrictions
	Capacity of the system is insufficient.	Too much load	Unload part of load with crane
		Pollution between the Floor profiles	Clean
		Frost	Thaw
5. Individual movement is incorrect when unloading With a full and empty trailer	Valve in cylinder head 1 or 2	Pollution prevents a good closure	Remove pollution
		Broken valve spring	Replace spring
	Valve seat in cylinder head 1 or 2	Valve seat has loosened	*Replace / fasten valve seat
	Common rail cylinder rod side	Stop in the common rail has loosened	Fasten stop / replace common rail
		Common rail mounted the wrong way around	Mount common rail correctly
6. Switching is difficult or goes not at all. 3 Cylinders are fully retracted or fully out.	a. Threaded rod	Adjustment incorrect	Adjust correctly, attention: determine cause. See: b. and c.
		Switching spring broken	Replace spring, attention: determine cause. See: b. and c..
	b. Switching plunjer	Stroke > 12 mm. [0.5"] -> threaded rod loose, spacer loose	Screw in threaded rod / bolt fully.
	c. moving cross member	Slanting caused by loose profiles	*Replace screws and provide them with a thread locking product and check the rod bearing.
	d. Switching choke	Polluted	* Clean choke
7. Other malfunctions	Please contact your trailer builder or Cargo Floor, keep the system number at hand.		

*Contact your trailer builder or Cargo Floor for a repair advise.

E-CONTROL

Control with loading / stop / unloading over a switch. As a standard provided with a manual override by means of a unique red “Cargo” rotary switch. (Optional: radio remote control.)

CONTROL VALVE

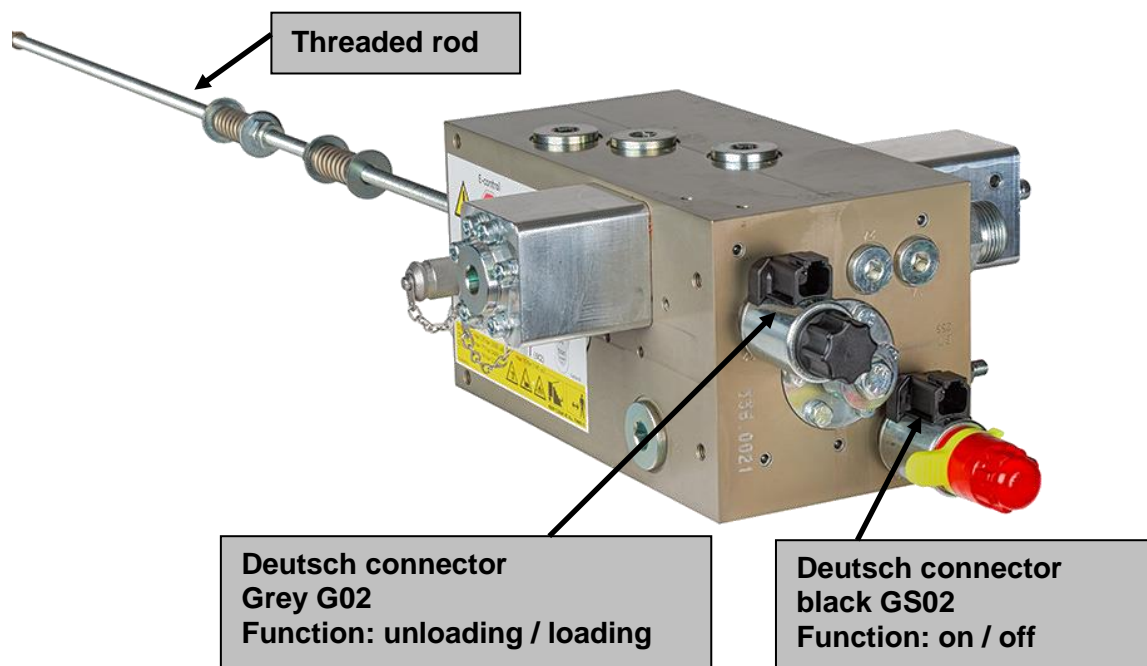

FUNCTION OF E-CONTROL SWITCHES

CF 7 SWITCH

The CF 7 switch is the permanent switch which is mounted in the control box and has 3 switch positions with the following functions:



← (Pos I) = loading

is activated when you turn the rotary switch to the left.

Pos 0 = stop

the rotary switch automatically returns to this position when the switch is released.

→ (Pos II) = unloading

is activated when you turn the rotary switch to the right.

In the interest of safety this switch is fitted with an automatic spring-back for positions I and II, so that it always returns to the central "0" position. This is necessary to prevent conflict situations arising when using the CF 8 remote control.

Mounted below the CF 7 switch, is a connector to which the CF 8 switch or the RX RECEIVER can be connected without the need for any adjustments.

Normally, the CF 7 switch should only be used if the CF 8 switch is defective.

If, after the initial assembly, the switch does not work it is probably because the connections for the + (brown) and the - (blue) have been swapped around. The supply cable contains a blocking diode which prevents damages arising from the + and - from being connected in reverse.

A 2 Amp fuse has been mounted in the CF 7 switch. Never mount a fuse over 3A, this can cause damage to the electrical installation

CF 8 SWITCH (MAIN CONTROL)

The standard supplied remote control CF 8, with 10 meter [30'] of cable, is used for the day-to-day control of the system.

The CF8 switch is fitted with the following control buttons:



Red button: the stop button. Press the button to activate it, and deactivate it by turning it to the right, the button will go back by itself.

Rotary switch. This is a rotary switch with three positions.

← (Pos I) = loading

is activated when you turn the rotary switch to the left. The button will automatically go back to the middle position when the button is released.

Pos 0 = stop

→ (Pos II) = unloading

is activated when you turn the rotary switch to the right to the stop position. This position is provided with a position lock.

The CF 8 switch has a plug connector, which can be inserted into the connector of the CF 7 switch and screwed tight.

To disconnect this, the duct must be unscrewed, after which the plug can be pulled out. Normally, this plug should always be connected to the connector.

OPTIONAL

A radio controlled remote control is available as an option.
 This incorporates:

CF RX Receiver

which has a plug connector which can be inserted into the connector of the CF 7 switch and screwed tight. To disconnect this the duct must be unscrewed, after which the plug can be pulled out. Normally, this plug should always be connected to the connector.



Red stop button

On the receiver RX a red stop button is mounted, by pushing this button you can stop the system in case of emergency. By pulling it the system will be activated again. Do take care, with reference to the accessibility, that when using a remote control, the door of the control box is opened so the red stop button can be operated.

Tilting switch

This receiver is supplied with a tilting switch, with this switch can de system be activated. Above the tilting switch are three LED's, they indicate that the power supply is present and the chosen switching action.

CF TX remote control

Fitted with three buttons, with the following functions:



Button 1 (load). By pushing this button the system will load, by releasing it the system will stop.

Button 2 (unload). By pushing this button the system will unload, by pushing it again the system will stop (or you push the red marked stop button).

Button 3 (stop). With this button you stop the system.

The red LED of the handheld remote flashes while the button is pressed.

MANUAL OVERRIDE E-CONTROL

In the event of a malfunction in the electrical system the electric valve can still be operated by activating the manual control fitted for that purpose.

MAKE SURE THAT THE DOORS ARE OPEN!

When using this manual override you must always ensure that it switched back to the original, NON-ACTIVATED condition after use.

Activation of the manual override: ON

Remove the yellow security clip and turn in (clockwise) the red button on top of the on/off GS02 solenoid till the stop.

Deactivation of the manual override: ON

Turn out (counter clockwise) the red button on top of the GS02 solenoid until the click and place back the yellow security clip. The system switch "off".

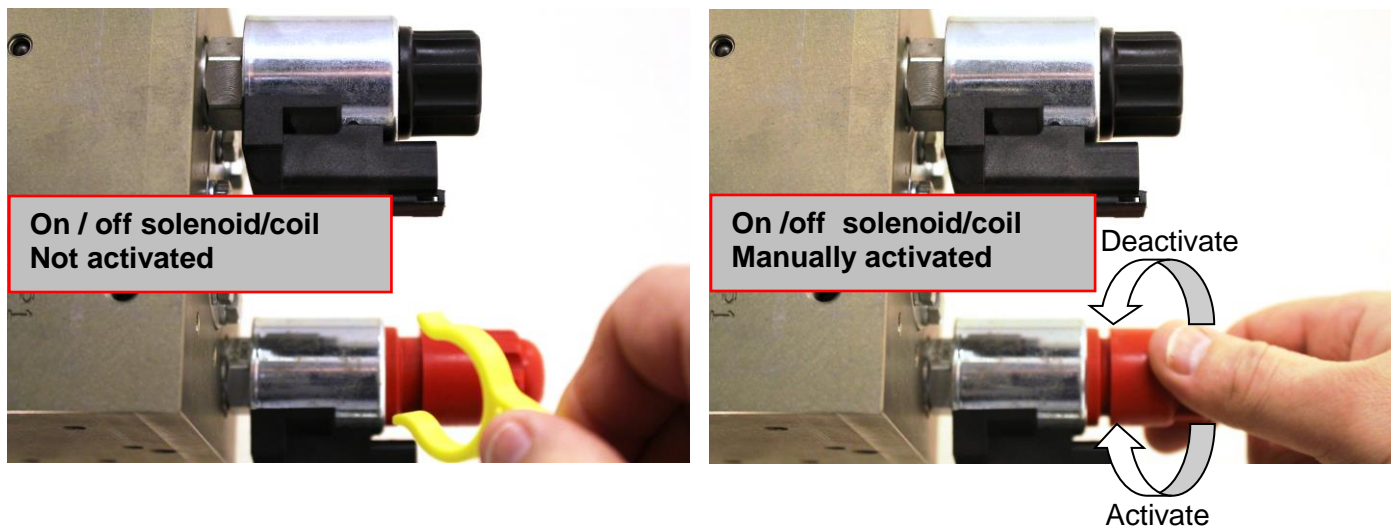

Activation of the manual override control loading (floor will only be able to load):

Screw the black cap off (pay attention to the O ring).

Turn out (counter clockwise) the screw under the cap of the load / unload G02 till the stop.

Deactivation of the manual override loading:

Turn in (clockwise) the screw under the cap of the load / unload G02 till the stop.

Screw the black cap back on (pay attention to mounting the O ring).

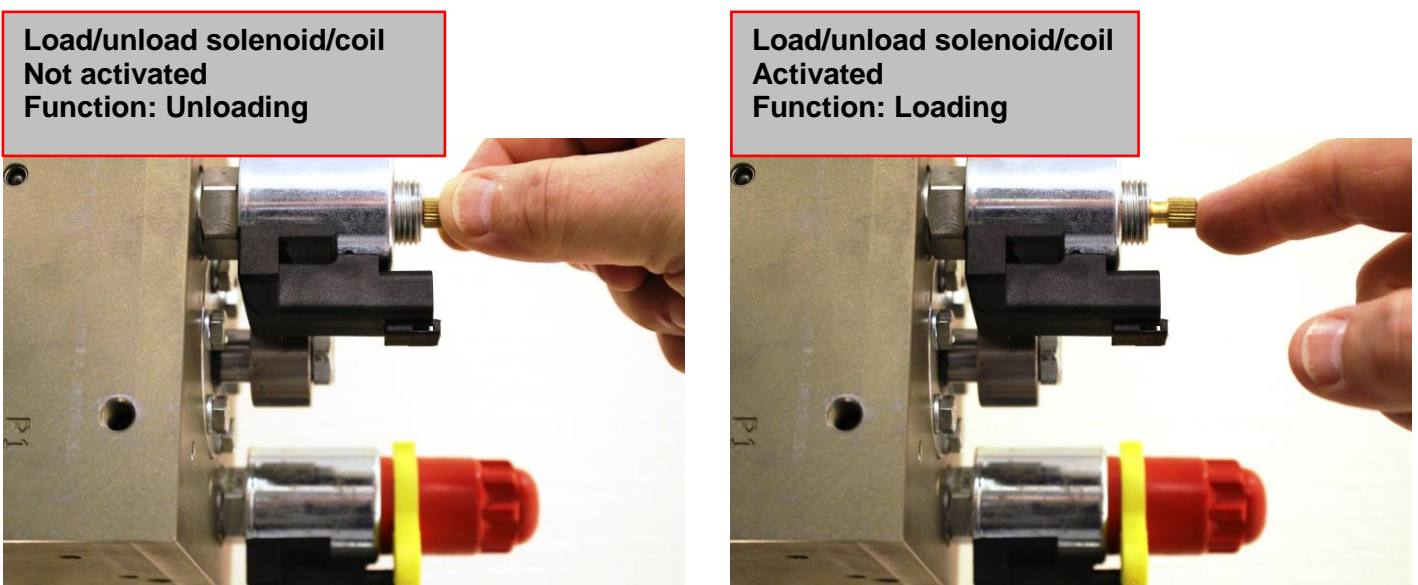

ELECTRICAL CIRCUIT DIAGRAM E-CONTROL

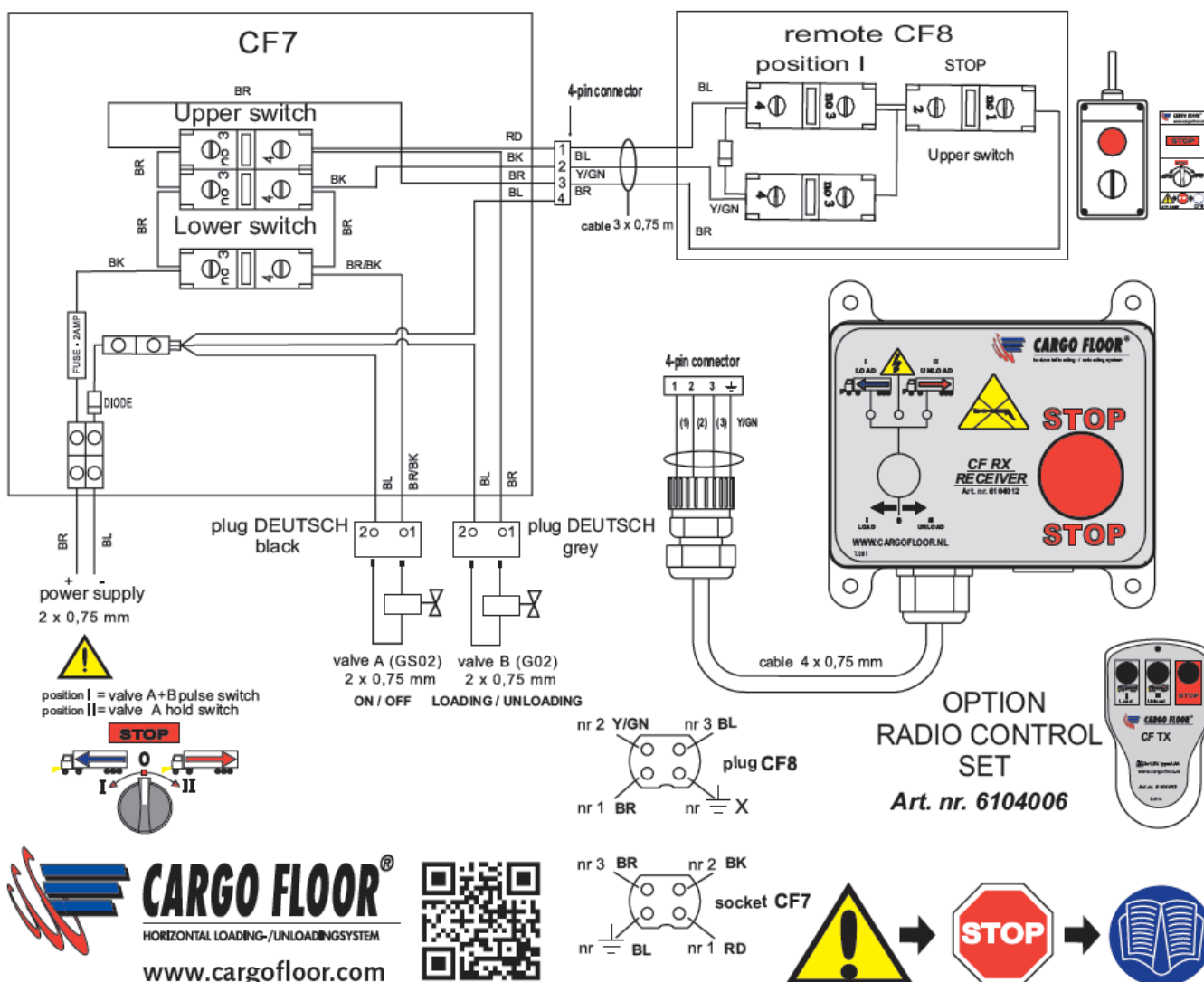

HYDRAULIC CIRCUIT DIAGRAM E-CONTROL

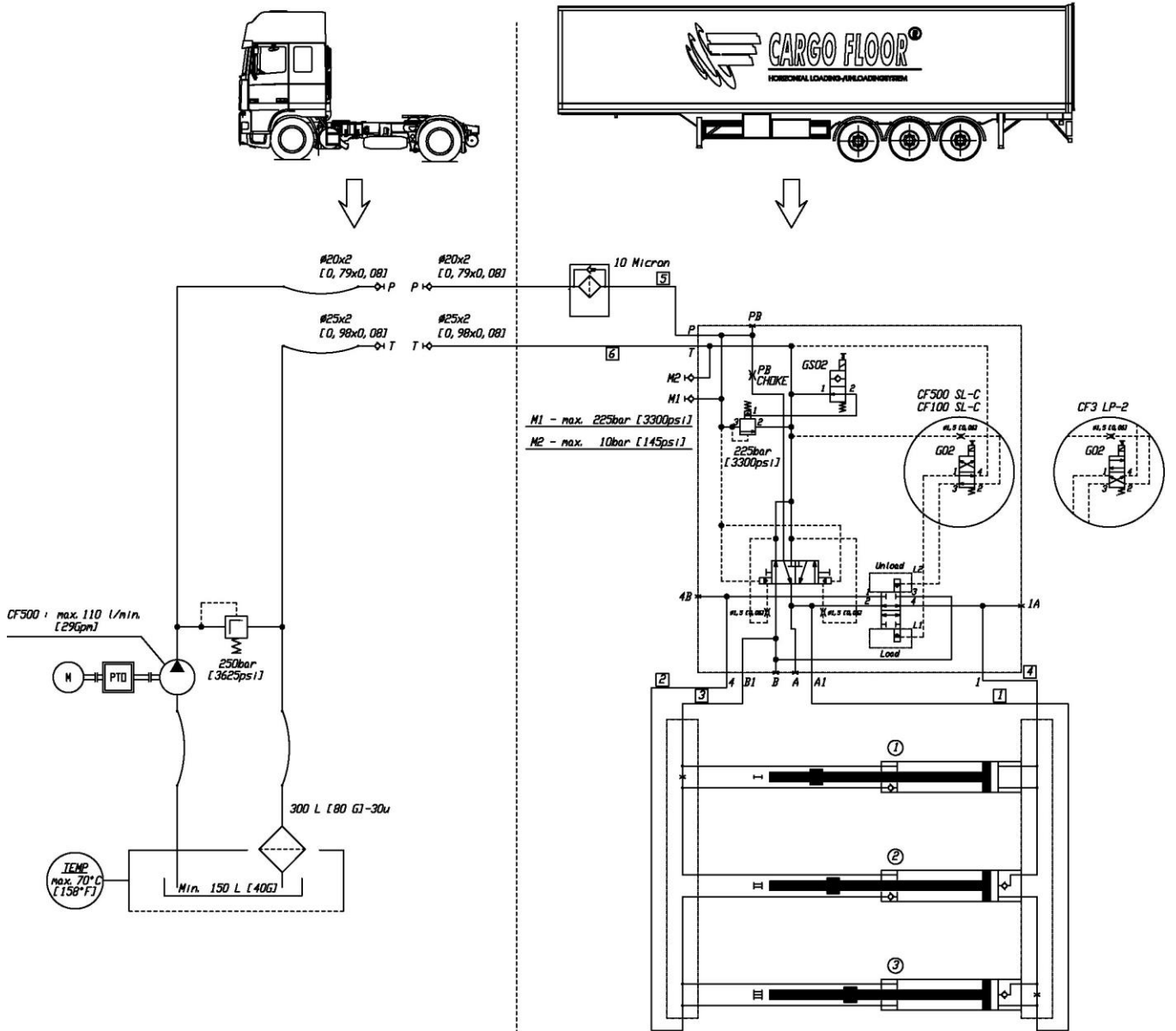

CHOKE

If the E-controlled Cargo Floor system will be operated by different types of pumps or a pump with a low oil flow, it could be that you have to pay attention to mount another type of choke.

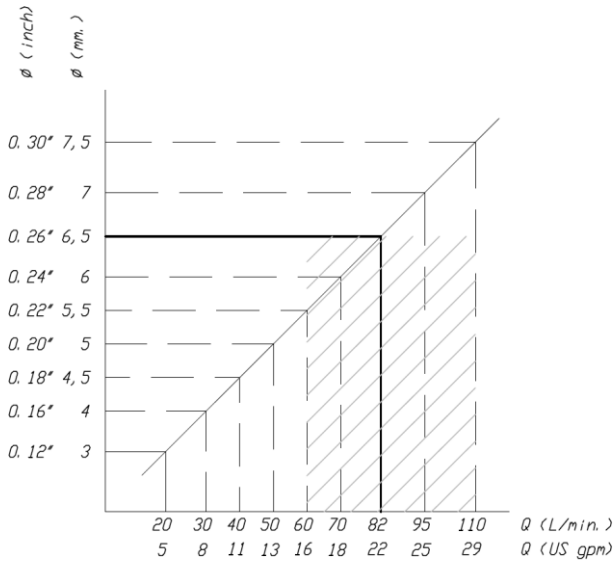

The shading points out the reach of the standard choke.

Standard choke
DIN 906-5.8-3/4"

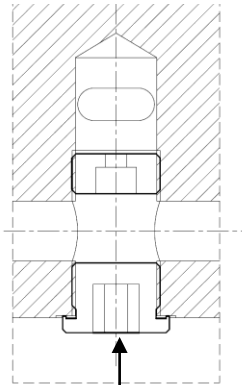

PB

Variabele
choke Art. nr.
7370106

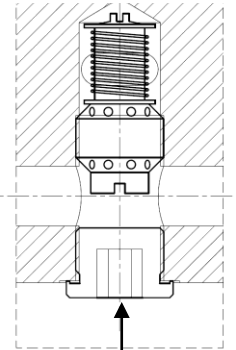

PB

Choke

There is a standard 6,5 mm [0.26"] choke mounted as standard in the PB channel of the E control valve. This allows the E control valve to function correctly. This standard choke is suitable for an oil flow level of 60 to 110 litres per minute [16 to 29 gpm]. The function of the control valve can be affected by a deviation from this oil flow level. The oil flow diagram shows which level of oil flow is required by which opening. Adjustment of this is possible by simply changing the diameter of the choke.

Known consequences of a wrong choke diameter are:

- Oil flow too low: load/unload operational plunger is not switching, system gets pressure less;
- Oil flow too high: noise in system, high heat dissipation and capacity loss.

Flow independent choke

As an option a flow independent choke can be supplied (variable choke article number 7370106). The standard mounted choke can simply be changed with these. You remove the socket plug out of channel PB (Allen key 12 mm). After this you screw the choke out of the channel with allen key 12 mm. Screw the new variable choke in the channel and fasten these by hand (about 15 Nm [11 lbf.ft.]). Screw the socket plug back into channel PB (allen key 12 mm) and fasten these by hand (about 15 Nm [11 lbf.ft.]). Let the floor run (loading and unloading) in order to check if everything is functioning well and no leakage occur. The variable choke has a flow range of 20-120 ltr./min [5-31 gpm] $\pm 10\%$ using a VG32 and is suitable for a maximal work pressure of 225 bar [3300 psi].



Important: connecting pressure and return wrongly will cause a malfunction, and damage to the system.

B- control

Another possibility to be independent from a variable oil flow is using a B-control. With this the loading/unloading direction is determined by a handle.

TROUBLESHOOTING E-CONTROL

In the event of the failure of the Cargo Floor system to operate (in the correct manner) when used in accordance with the operating instructions carry out the following checks:

Malfunction system	Concerns part	Cause	Solution
1. Does not operate No oil flow control valve	PTO	Not switched on	Switch on PTO
	Quick coupling	Blockade	Check couplings / mount correctly
2. Does not operate There is oil flow control valve	Remote control	Manual override operated	De-activate manual override
	Solenoid valve GS02 on/off	Interruption wiring Interruption in coil	Activate manual override GS02 temporarily and/or repair power supply
	Pressure control valve	Polluted	Clean / replace pressure control valve, attention: do not open the pressure control valve in parts
	Operation plunjer in the middle position	Flow <60 l/m [16 US gpm] See chapter: choke	Increase pump rpm Install another pump Adjust choke
		Hoses connected reversed	Check filter first, then connect pressure and return correctly.
		Plunjer moves with difficulty due to molten seal	Replace seals operation plunjer
3. Starts immediately after switching on the PTO	Switch CF7	Switch movement blocked in the on position	Remove blockade
	GS02 on/of	Manual override activated	De-activate manual override, put yellow security clip back in place
	Hoses connected reversed	Pressure and return hoses are swapped	Check filter first, then connect pressure and return correctly.
4. Individual movement is difficult and/or incorrect with a full trailer	Pressure control valve	Tipper valve	Turn tipper valve in correct position
		Pressure control valve pulling vehicle max. pressure to low	Measure max. pressure/ adjust pulling vehicle
		Return oil has restrictions	Measure pressure M2, remove restrictions
	Capacity of the system is insufficient.	To much load	Unload part of load with crane
		Pollution between the profiles	Clean
		Frost	Thaw
5. Individual movement is incorrect when unloading With a full and empty trailer	Valve in cylinder head 1 or 2	Pollution prevents a good closure	Remove pollution
		Broken valve spring	Replace spring
	Valve seat in cylinder head 1 or 2	Valve seat has loosened	*Replace / fasten valve seat
	Common rail cylinder rod side	Stop in the common rail has loosened	Fasten stop / replace common rail
		Common rail mounted the wrong way around	Mount common rail correctly

Malfunction system	Concerns part	Cause	Solution
6. Switching is difficult or goes not at all. 3 Cylinders are fully retracted or fully out.	a. Threaded rod	Adjustment incorrect	Adjust correctly, attention: determine cause. See: b. and c.
		Switching spring broken	Replace spring, attention: determine cause. See: b. and c..
	b. Switching plunjer	Stroke > 12 mm. [0.5 inch] -> threaded rod loose, spacer loose	Screw in Threaded rod / bolt fully.
	c. Moving cross member	Slanting caused by loose profiles	*Replace screws and provide them with a thread locking product and check the rod bearing.
	d. Switching choke	Polluted	* Clean choke
7. Floor unloads when choosing loading and unloading	Solenoid valve G02 loading / unloading	Interruption wiring Interruption in coil	Activate manual override G02 temporarily and/or repair power supply
8. Floor loads when choosing loading and unloading	Solenoid valve G02 loading / unloading	Manual override G02 is activated	De-activate emergency control
9. Other malfunctions	Please contact your trailer builder or Cargo Floor, keep the system number at hand.		

* Contact us for the right repair advice.